

# WIRED VIDEO-TRACKING CONFERENCE CONTROL SYSTEM

## Operation Instructions

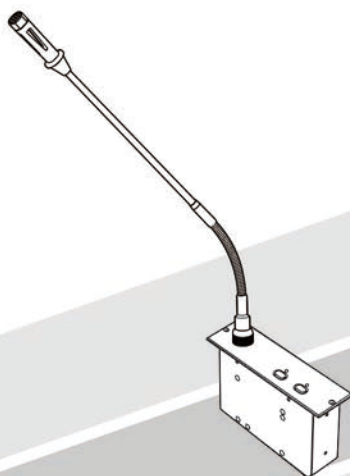

This instruction manual includes several types of microphone and receiver. Read the relevant chapters according to the type before usage. Keep it for future reference.

# Foreword

Thank you very much for choosing our company's professional wired conference control system series. In order to make full use of the product, we highly suggest you read the instruction manual before usage.

This series of professional wired conference system adopt touch key and LCD screen in front of the panel to control and show working status, six working mode can be chosen, break through traditional dial code control, more intuitive and humanization. This series product use hand in hand way to connect, easy installation and get stable performance.

This product connection easily, add number freely, can connect expander machine to extend more and more units.

Suitable for variety of meeting occasion.



# Content

|   |          |
|---|----------|
| 1.Safe instructions .....                                   | 1        |
| 2.Feature .....   | 2        |
| 3. System control unit operation instruction .....          | 3        |
| 3.1System control unit operation .....                      | 3        |
| 3.2System control unit front panel .....                    | 4        |
| 3.3System control unit back panel .....                     | 4        |
| 3.4LCD screen function diagram .....                        | 5        |
| <b>4. Instruction for chairman unit/delegate unit .....</b> | <b>7</b> |
| 4.1 Functions and operation .....                           | 7        |
| 4.2 Installation diagram .....                              | 7        |
| 5. Parameters .....   | 8        |
| 5.1 System control unit parameter .....                     | 8        |
| 5.2 Chairman unit/Delegate unit parameter .....             | 8        |
| 6. PC operation diagram .....                               | 9        |
| 6.1 Interface of system setting .....                       | 9        |
| 6.2 Unit microphone setting interface .....                 | 9        |
| 6.3 Camera setting interface .....                          | 10       |
| 7. Remote teleconference step .....                         | 10       |
| 8. Solutions to breakdowns .....                            | 11       |
| 9. Connection instruction .....                             | 12       |

## 1. Safety instructions

- Read this instruction manual.
- Keep this instruction manual for future reference.
- Follow all instructions in this instruction manual.
- Do not place the product near any heat sources such as radiators, stoves, or other devices that product heat. If you are not going to use the product for a long time, pull out the battery. Do not throw or drop the product in case it causes severe damages.
- Be aware of the supply voltage. Only the supply voltage listed on the instruction manual fits the product.
- Only use accessories specified by our company.
- Never take apart the device. If devices are took apart by customers in breach of this instruction, the warranty becomes null and void. Turn to the professional mechanic or local dealer for help if there is something wrong with the product.
- If components are needed to replaced, replace them with original components produced by our company.
- Leave the devices the minimum space of 30 mm for proper ventilation. Do not cover the vent with newspapers, cloths, curtains, etc.  
Do not place the devices near fire or water.  
Only professional mechanic can assemble the devices if it is labeled with hazard warning sign “⚡” .  
Recycle the replaced battery.  
The devices can be used in tropical or temperate regions.



Only for safe use in the area with an altitude of below 2,000 meters.



The equipment can be used in non tropical climates

## 2. Features

1. Latest digital line designed, data transmission stability, good anti-interference, high quality sound, suitable for every conference place.
2. Adopt use high shielding performance cable, increase the ability of anti-interference.
3. The control unit has four roads output, 4 roads can contact with 60 units at the same time, each road can contact to 20 units, also can be connected to expand machine to expanding more than 60 units at the same time.
4. This product can realize real-time video-tracking function, support four-way video signal input, 2 way video-signal output.
5. This series product supply PC software which can connect with the computer to realize the controller setting function synchronized.
6. The product built-in telephone coupler input and output interface, through communication principle to equip voice signal input and output in order to control the remote teleconference, support telephone dial-out and pick up. Realize teleconference.
7. The product use  $240 \times 128$  large LCD pixel to display setting contents, hierarchical menu designed which make operation clear and humanized.
8. The product have 7 conference mode: FIFO, LIMITED mode, free discussion mode, chairman only, LIFO, Vies to answer first mode, apply mode 1-6 people or the whole unit can speak at the same time (Chairman unit don't count inside).
9. The product back panel equipped with feedback button, put on the button can prevent the noise, enlarge the volume, increase the sound pick-up distance, high fidelity, suitable for different occasions.
10. There are XLR plug, 6.3 plug and RCA three kinds output plug, adjust to connect with many other kinds of audio equipment.
11. This series products have automatic mute and scale eliminating circuit, and eliminate the impact of the switch machine, avoid the shock and noise affect the atmosphere even damage amplification equipment and speakers.
12. Recording function make conference recording convenient.

### 3. System control unit operation instruction

#### 3.1 System control unit operation

1. Connect the units with unit cables. Connect the first units with the controller unit with the controller cable.
2. Connect the power cable with the controller unit, put on the power button. Controller will come out a sound of "di" the microphone gooseneck ring will twinkle several times continuously for checking the whole system. LCD screen show real-time working data.
3. Press "ENTER" key in the menu setting. Press up button "▲" or down button "▼" to setting the necessary mode and setting. Press "ESC" exit.

##### 1) Conference speak mode

- ① FIFO mode: first in first out, can choose 1-6 people speak at the same time. This mode means after reaching limit number, finally open unit will cover the first open unit.(example: set the number to 3, there is unit A, unit B, unit C, unit D, A is the first open, when the fourth one D open, then the first unit A will shut down automatically quit).
- ② LIMIT mode: can choose speak number from 1-6, means the number of units open at the same time can be set to 1-6 numbers(excluded chairman unit).
- ③ FREE mode: default on "N" key light, means the number of speak units at the same time without limit.
- ④ CHAIRMAN mode: speak number will default "N" key on, means only allowed chairman microphone to speak.
- ⑤ LIFO mode: Last in first out, can choose speak number with 1-6 number, means after reaching limit number, finally open unit cover the unit open in front of the final unit.(example: set the number to 3, there is unit A, unit B, unit C, unit D, when the finally D open then the third unit C will shut down automatically quit)
- ⑥ Vies to answer first mode: default on "1" people to speak, means only 1 unit can speak.
- ⑦ Apply for speech mode: all delegate unit can be speak after be allowed by chairman unit, delegate unit number can be setting from 1-6, this mode just support for some units which have apply for speech mode.

2) Speaker number: 1-6 people or N people, N means all can speech. 7 speech number mode to choose.

3) Input volume: press "VOL+" key increase volume.

4) Output volume: press "VOL-" key reduce volume.

5) Teleconference: can use to be open remote teleconference, there are open and close to choose

6) Unit setting

##### ① Unit allocation

Camera NO.: One controller can support 4 cameras, use left key "◀" or right key "▶" can setting camera number "000-003"

Preset point: One controller support 255 units preset point.

※ When enter in the unit allocation interface, all the units which connected with host unit, lamp ring and button indicator light will flash. By default under the condition of the same camera (for example 000), set the camera number in the host, preset point is the default initial values "001", press the first setting unit's speech key, then the lamp right and speech indicator light off means the setting is completed the first unit allocation. At this time, host LCD screen display value NO. "002", press the second units speech button to complete the allocation setting for the second units. Others unit use the same setting method. If you want to set up other camera, change the camera values in the host is ok.

② Unit reset: this can clear all the distributed unit data.

##### 7) Camera setting

① Video adjustment: adjust the default point(preset point) location and visual effect.

② Communication protocol: "PELCO-D", "PELCO-P" "VISCA" for choose.

③ Camera reset: this can clear all the allocated camera preset points data.

## 3.2 System control unit front panel

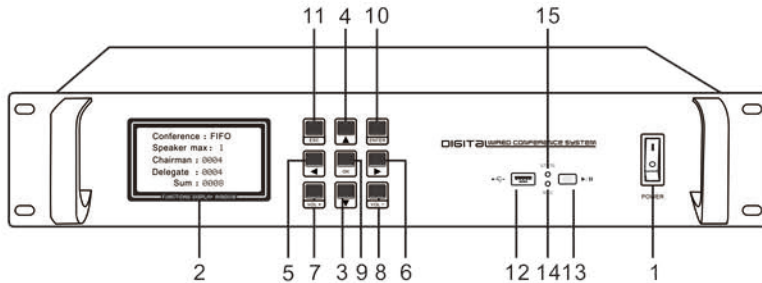

- |                       |                             |                     |
|-----------------------|-----------------------------|---------------------|
| 1. Power switch       | 2. LCD screen               | 3. up key           |
| 4. down key           | 5. left key                 | 6. right key        |
| 7. increase volume    | 8. reduce volume            | 9. OK               |
| 10. menu              | 11. exit/return             | 12. USB disk port   |
| 13. Record on/off key | 14. USB recording indicator | 15. USB power light |

## 3.3 System control unit back panel

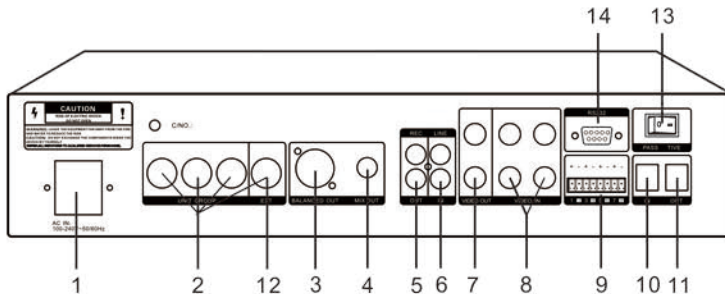

- |                                |                                   |                              |
|--------------------------------|-----------------------------------|------------------------------|
| 1. AC power socket             | 2. unit microphone connect        | 3. balanced audio output     |
| 4. 6.3 unbalanced audio output | 5. RCA output                     | 6. RCA input                 |
| 7. video output                | 8. video input                    | 9. camera control RS485 port |
| 10. telephone coupler input    | 11. telephone coupler output      |                              |
| 12. extender interface         | 13. prevent noise function button |                              |
| 14. PC RS232 port              |                                   |                              |

## 3.4LCD screen function diagram



figure 1:Menu Set

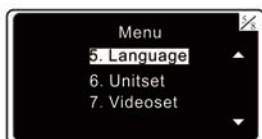

figure2: Speech mode set



figure3:FIFO mode

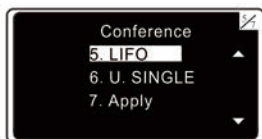

figure4:Limited speak

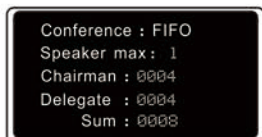

figure5: Free mode



figure6:Chairman special mode

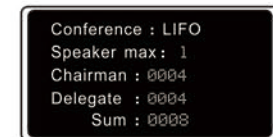

figure7:LIFO mode

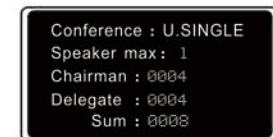

figure8:Vies to answer mode



figure9: Apply for speech mode

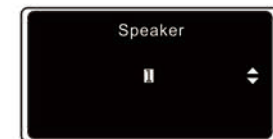
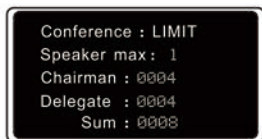

figure10:Speaker NO. set



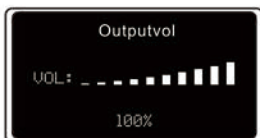

figure11: Output volume set

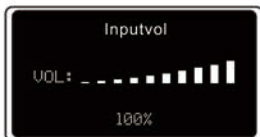

figure12: Input volume set



figure13: Teleconference set

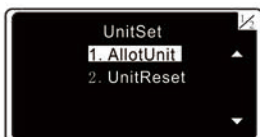

figure14: unit setting



figure15: unit allocation



figure16: unit reset



figure17: camera setting

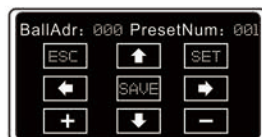

figure18: video adjustment

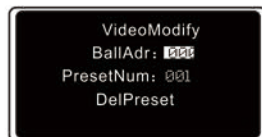

figure19: video adjustment

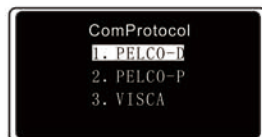

figure20: communication protocol

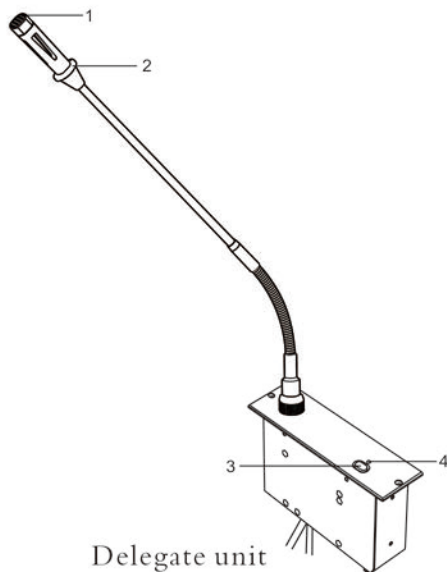
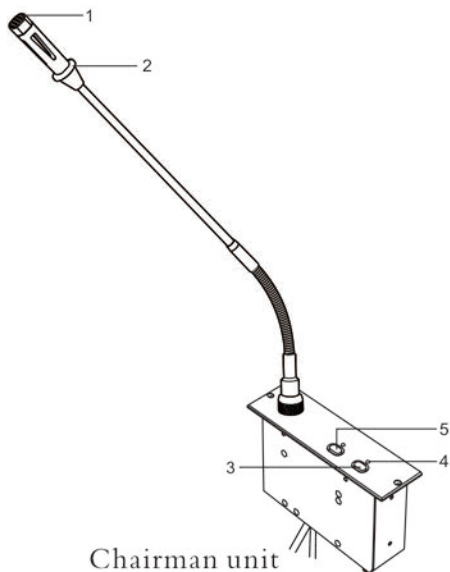

figure21: communication protocol confirmation

## 4. Instruction for chairman unit/delegate unit

### 4.1 Functions and operation

1. Connect the microphone base with the gooseneck microphone, connect with the connect cable.
2. Press the speech key ,indicator light in gooseneck ring,means enter in the working status.
3. Press priority key of the chairman unit can shut the other working on delegate units.



1. microphone head  
4. speech indicator light

2. light ring  
5. chairman priority key

3. speech key

### 4.2 Size

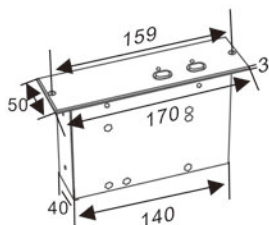

Measurement unit: mm



## 5. Parameters

### 5.1 System control unit parameter

|                  |   |
|------------------|---|
| Power supply     | : AC 100-240V~50/60Hz                                   |
| Output impedance | : RAC:200OLINE:200O<br>BALANCE: 300O<br>UNBALANCE: 400O |
| Input impedance  | : LINE:50KO PBIN:50KO                                   |
| S/N ratio        | : 100dB (1KHz THD1%)                                    |
| Size for case    | : 480×360×85mm  |
| Accessory        | : 10m 8P shielded cable                                 |

### 5.2 Chairman unit/Delegate unit parameter

|                     |   |
|---------------------|---|
| Type                | : capacitance                                   |
| Polar pattern       | : one direction                                 |
| Frequency response  | : 30Hz-18KHz                                    |
| Sensitivity         | : -45±2dB@1KHz                                  |
| Input voltage       | : DC 9V (powered by host)                       |
| Min input impedance | : 1KΩ   |
| S/N ratio           | : 68dB  |
| cable               | : 2.0M 8P shielded cable with the unit directly |
| Accessory           | : windshield                                    |

## 6. PC operation diagram

After insert the software U disk in computer, open the folder "SETUP" installer and complete the installation. Then open software "wired conference system 1.0", user can set the function in the setting screen.

### 6.1 Interface of system setting

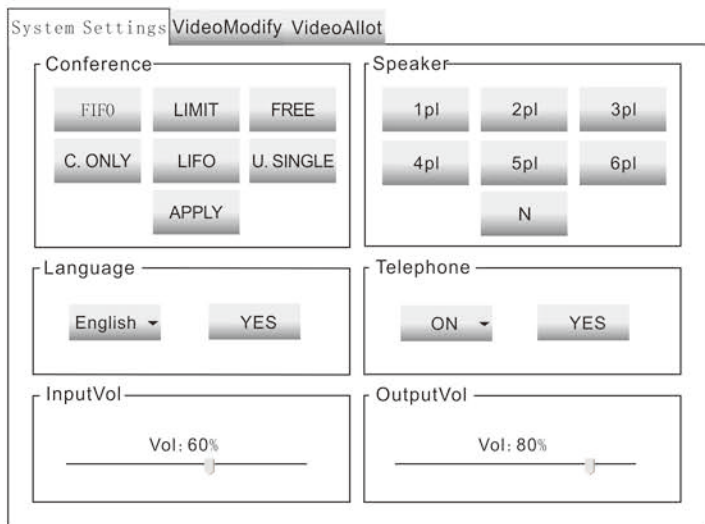

### 6.2 Unit microphone setting interface

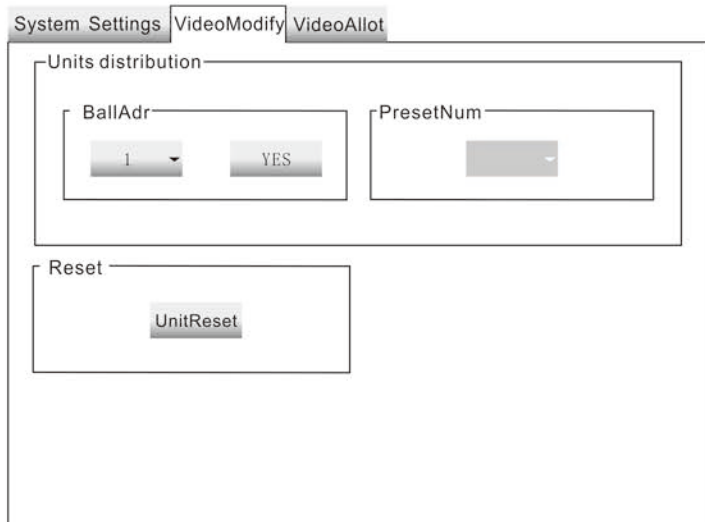

## 6. PC operation diagram

### 6.3 Camera setting interface

The screenshot displays a software interface for camera settings. At the top, there are three tabs: 'System Settings', 'VideoModify', and 'VideoAllot'. The 'VideoModify' tab is currently selected. The interface is organized into several sections:

- BallAdr:** A dropdown menu showing '1' and a 'YES' button.
- PresetNum:** A dropdown menu showing '2' and a 'YES' button.
- VideoSet:** A central area containing a grid of control buttons: 'OK', an up arrow, 'Del', a left arrow, a right arrow, a plus sign, a down arrow, and a minus sign.
- Comprotocol:** A dropdown menu showing 'PELCO-D' and a 'YES' button.
- Reset:** A 'BallReset' button.

## 7. Remote teleconference step

1. Let the telephone and telecom signal connect to the host system, ensure the normal communication and adjust the amplification to a good status.
2. Use the telephone dial telephone IP connect to the telephone NO., choose teleconference mode in the host, adjust to the suitable volume, put the telephone hang up can be broadcast to communicate with each other.
3. Close the teleconference mode can be restored the telephone function.

## 8. Solutions to breakdowns

| Breakdowns                      | Causes  | Solutions                                      |
|---------------------------------|---|--|
| No power after connect          | System control unit haven't opened the power                                  | Open power                                     |
|                                 | Mains socket without power  | Check the mains socket                         |
| No voice after turn on the unit | Haven't connect the host audio output   | Connect audio output                           |
|                                 | Audio equipment have open the volume  | Open the volume                                |
| LCD screen display""            | Power didn't enough because of connecting line too long or over unit quantity | Using less microphone or add extension machine |
|                                 | Under chairman mode   | Setting other speech mode                      |
| No voice after turn on the unit | Audio transfer cable not connection   | Connect audio output cable                     |
| Only one microphone can be open | Set up speak number   | Change to 3,6 or N mode                        |
| Buzzer continuous ring          | Haven't connect the unit microphone   | Connect the unit microphone                    |
|                                 | Cable didn't connect well   | Check the connection                           |

## Care and maintenance

Before fixing or cleaning the device, cut off the electricity supply. Clean it with soft cloth.

For spots, clean it with cloth that has neutral cleaning solvent and dry it with another cloth.

Do not use gasoline, diluents or any other chemical product, or else the surface will be damaged.

## 9. Connection instruction

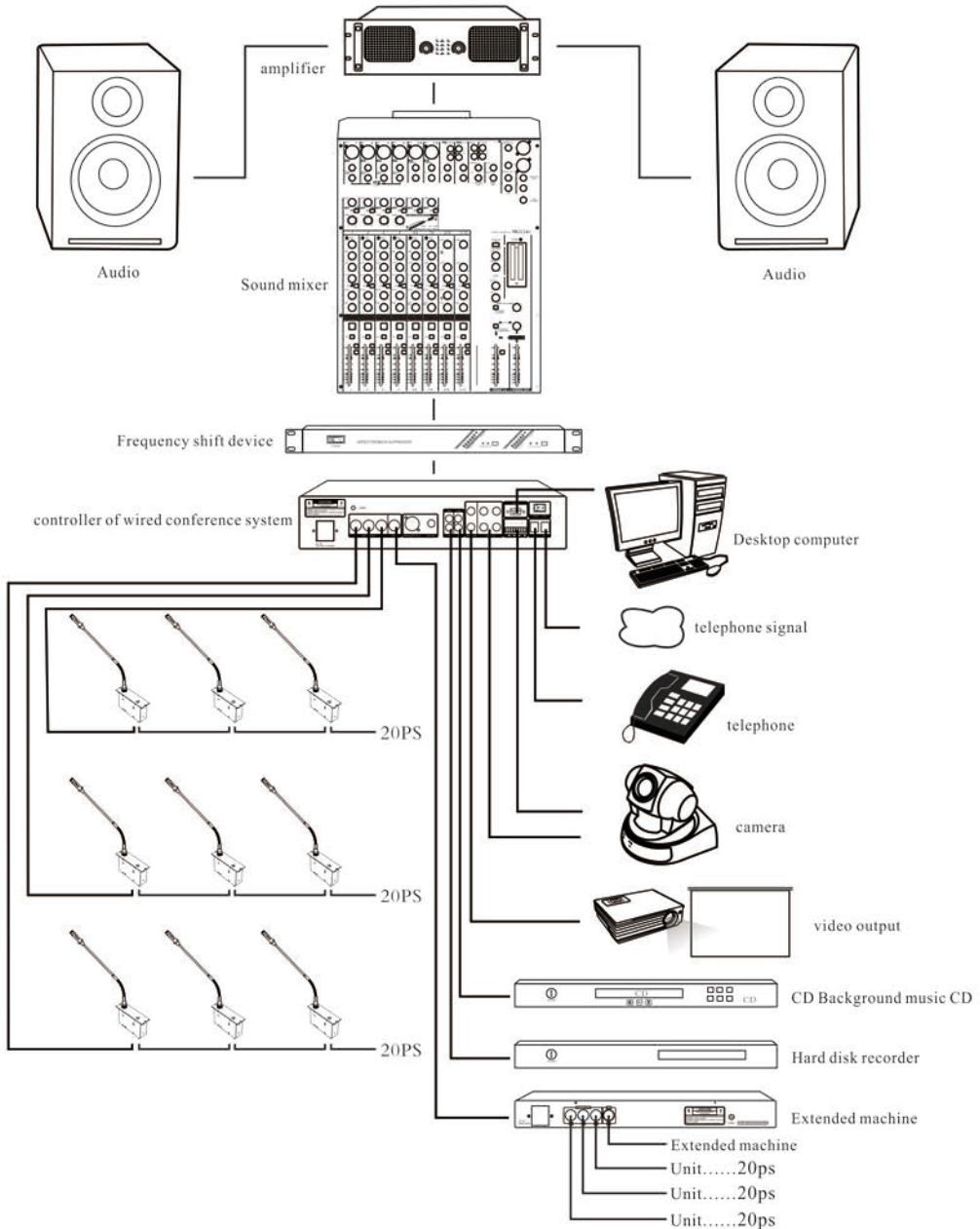

This operation manual would be revised at any time without prior notice.

This manual contains needed information as much as possible. If there is anything unclear, wrong or omitted, please don't hesitate to contact us for confirmation. The company is free from all the damage and loss caused by no confirmation.

For testing and maintenance, please contact us or our authorized distributors through the dealer from whom you purchased this product. The company assumes no responsibility for any loss or damage resulting from testing and maintaining this unit by unqualified personnel.